

FLEXITRAILER FT-LS-S

Technische gegevens

Geschikt voor

Schoteldruk
 Maximale aslast per as
 Totaal toegestane massa
 Leeggewicht
 Nuttig laadvermogen
 Schotelhoogte
 Chassishoogte
 Bandenmaat
 Elektrische aansluitingen

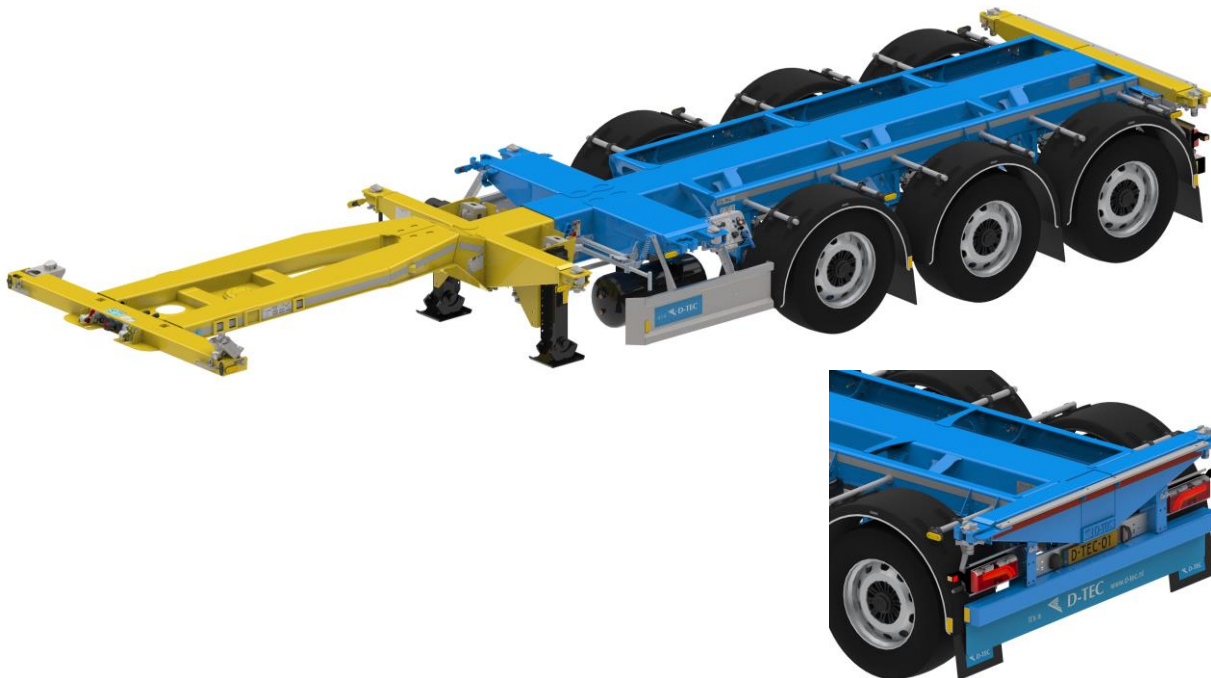

Technische Daten

Geeignet für

Sattellast
 Max. Achslast per Achse
 Gesamt zulässige Masse
 Leergewicht
 Nutzlast
 Sattelhöhe
 Chassishöhe
 Reifengröße
 Elektrische Anschlüsse



Technical data

Suitable for

Kingpin weight
 Maximal Axleload / axle
 Gross trailer weight
 Empty weight
 Payload
 Fifthwheel height
 Chassisheight
 Tyresize
 Electrical connectors

FT-LS-S

20 ft rear
 20 ft central (optional)
 30 ft (optional)
 2x 20 ft
 40 ft (HC)
 45 ft
 16.000 kg
 9.000 kg
 43.000 kg
 4.600 kg
 38.400 kg
 1.110 mm
 1.110 mm
 385/55 R22,5
 1x 15 pin

OPTIES / OPTIONEN / OPTIONS

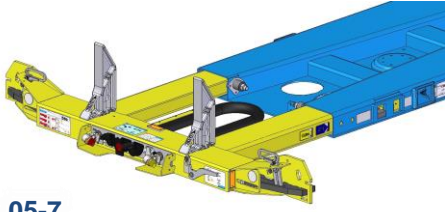

05-7

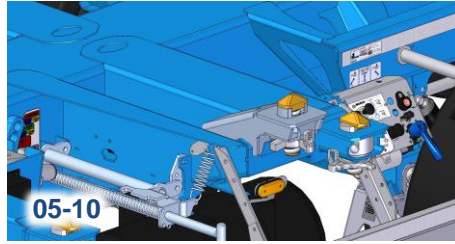

05-10



05-11

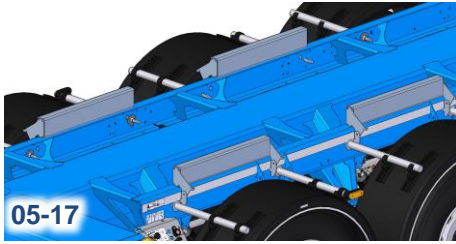

05-17



11-2-17



11-15



15-17



15-14



15-15

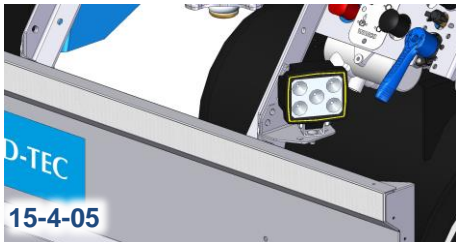

15-4-05



15-4-07



07-NS-9

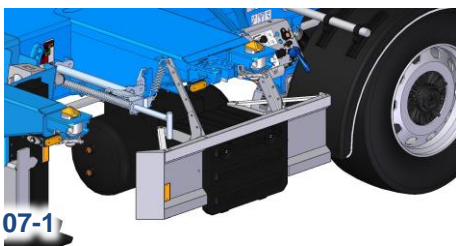

07-1

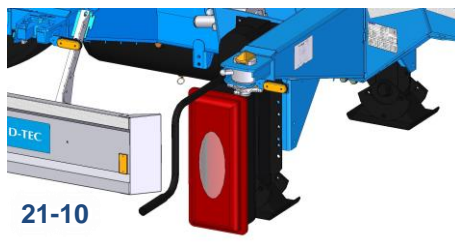

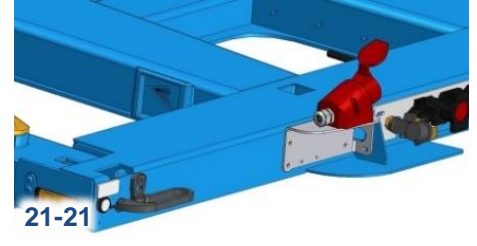

21-10



21-21



07-NS-12/13/14

		
Basis opties	Basis Optionen	Basic options
11-4-15 Valx trommelrem	Valx Trommelbremsen	Valx drum brakes
11-FT-1 As 1 liftas automatisch / manueel	Achse 1 Liftachse automatisch	Axle 1 liftaxle automatic / manual
19-55 Bandenmaat 385/55R22,5	Reifengröße 385/55 R22,5	Tyresize 385/55 R22,5
19-B Banden keus D-TEC	Reifen nach Wahl D-TEC	Tyremake D-TEC choice
1 laags 2K natlak RAL 5015 / 9005	1 Schicht 2K RAL 5015 / 9005	1-Layer coating 2K RAL 5015 / 9005
09-1-2 Bovenzijde schooperen	Oberseite spritzverzinkt	Topside schooping
05-7 Flexilock voor 45' legaal	Flexilock für 45' legal	Flexilock for 45' legal
05-11 20ft centraal console	20' mittig Position	20ft central position
21-5 2 Wielkeggen	2 Radkeile	2 Wheelwedges
21-16 Containerstops	Containerstops	Containerstops
Comfort opties	Komfort Optionen	Comfort options
05-10 Flipover console	Flipover Konsole	Flipover console
05-17 Klapkokers ivm geen tunnel	Klappstützen für Container ohne Tunnel	Filling pieces due to no tunnel
07-1 Kunststof gereedschapskist L / R	Kunststoff Werkzeugkasten L / R	Plastic toolbox left or right
07-5 Gevaarlijke stoffen bord	Gefahrgutschild	ADR sign at the rear
07-28 A-bord	A-Schild	A-Sign
07-NS-9 Reclameplaat	Werbungstafel aus Stahl am Heck	Steel plate at the rear, painted
BPW / VALX/ Jost / SAF schijf	BPW / VALX/ Jost / SAF Scheibe	BPW / VALX/ Jost / SAF disc
BPW trommelremmen	BPW Trommelbremsen	BPW drumbrakes
11-FT-2 As 1 liftas automatisch, as 3 manueel	Achse 1 Liftachse aut., Achse 3 man.	Axle 1 liftaxle automatic, axle 3 man.
11-FT-3 As 1 en 3 liftas automatisch	Achse 1 und 3 Liftachse automatisch	Axle 1 and 3 liftaxle automatic
11-FT-S2 As 1 en 3 liftas manueel	Achse 1 und 3 Liftachse manuell	Axle 1 and 3 liftaxle manual
09-1-1 Volledig schooperen	Völlig spritzverzinkt	Full schooping
Standard Coating in RAL 3002,	RAL 5002, RAL 5010, RAL 5015,	RAL 7016, RAL 7021, RAL 9005
09-5-20 Zijafscherming wit gespoten	Seitlicher Anfahrerschutz in weiss lackiert	Sideguards in white
09-5-01 Steunpoten en ketel in chassiskleur	Stützbeine und Luftkessel in Chassisfarbe lackiert	Landing legs + air res. in chassis color
09-6-SP spuiten 2-laags 2K natlak naar keuze	Lackieren 2 Schicht 2K nach Wahl	2-Layer coating 2K customer choice
11-2-17 laatste as naloop gestuurd	Letzte Achse nachlaufgelenkt	Last axle steeringaxle
11-15 ATO	ATO	ATO
2, 4 of 6 ronde 3-kamer lampen	2, 4 oder 6 ronde Rückleuchten	2, 4 or 6 round 3 chamber rear lights
15-1 15-polige stekker met 2x7p ISO-N+S	15-poligen Stecker mit 2x7p ISO N+S	15-pin connector with 2x7p ISO N+S
15-16 Alle lampen in led uitvoering	Komplette Beleuchtung in LED	All lights at the rear in LED
15-4-05 Led werklampen op de zijafscherming	LED Arbeitsscheinwerfer auf seitlicher Anfahrerschutz	LED worklights on sideguards
15-4-07 Led werklampen achter	LED Arbeitsscheinwerfer am Heck	LED worklights at the rear
17-19 Reservewieldrager	Reserveradträger	Sparewheelcarrier
D-TEC spatlap blauw / zwart / wit	Schmutzfänger blau / schwarz / weiß	D-TEC mudflap blue / black / white
19-65 Bandenmaat 385/65R22,5.	Reifengröße 385/65 R22,5	Tyresize 385/65 R22,5
Continental / Hankook	Goodyear / Bridgestone	Michelin
19-7-3 Alcoa Durabright 6 alu velgen	Alcoa Durabright 6 alu Felgen	Alcoa Durabright 6 alloy rims
19-8-3 6 aluminium velgen hoogglans	6 Aluminium Felgen poliert	6 aluminum rims polished
Reservewiel staal 385/65 of 55	Reserverad Stahlfelge 385/65 oder 55	Sparewheel steel 385/65 or 55
21-6 Houder met 6 kg brandblusser	Halter mit 6kg Feuerlöscher	Holder with 6kg fire extinguisher
21-10 Houder zonder 6 kg brandblusser	Halter ohne 6kg Feuerlöscher	Holder without 6kg fire extinguisher
21-21 Voorbereiding genset	Vorbereitung Genset	Genset preparation

