



# COMBITRAILER CT-521-S



 Technische gegevens	 Technische Daten	 Technical data	CT-521-S	CT-F22-S	CT-R31-S
Geschikt voor	Geeignet für	Suitable for	20 ft 2x 20 ft 40 ft (HC)	20 ft	20 ft
Schoteldruk	Sattellast	Kingpin weight	17.000 kg	17.000 kg	17.000 kg
Max. aslast per as	Max. Achslast pro Achse	Max. Axleload / axle	9.000 kg	9.000 kg	9.000 kg
Tot. toegestane massa	Gesamt zulässige Masse	Gross trailer weight	62.000 kg	35.000 kg	44.000 kg
Leeggewicht	Leergewicht	Empty weight	8.200 kg	3.700 kg	4.500 kg
Nuttig laadvermogen	Nutzlast	Payload	44.800 kg	31.300 kg	39.500 kg
Schotelhoogte	Sattelhöhe	Fifthwheel height	1.110 mm	1.110 mm	1.110 mm
Chassishoogte	Chassishöhe	Chassis height	1.110 mm	1.110 mm	1.110 mm
Bandenmaat	Reifengröße	Tyresize	385/55 R22,5	385/55 R22,5	385/55 R22,5
Electr. Aansluitingen	Elektrische Anschlüsse	Electrical connectors	15 pin only	15 pin only	15 pin only
Stuuras (-sen) op as	Lenkachse (-n) auf Achse	Steeringaxle on axle	1,2,5	.*	3
Liftas (-sen) op as	Liftachse (-n) auf Achse	Liftaxle on axle	1,2,3,5	1	1,3
Douanestand	Zollstellung	Costoms-position			

## OPTIES / OPTIONEN / OPTIONS

05-17

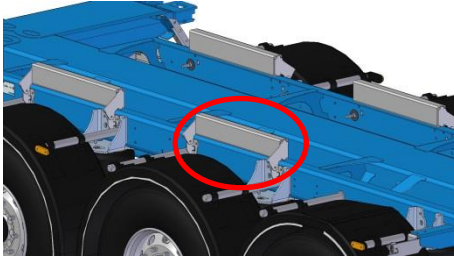

07-1

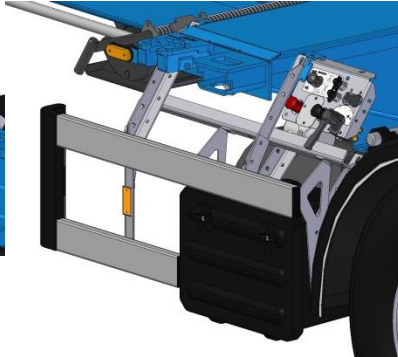

07-2

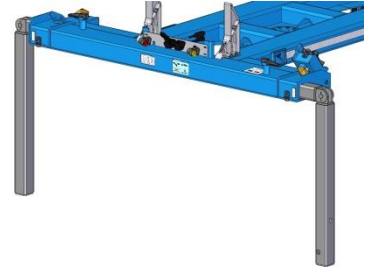

15-12



07-NS-9



07-NS-39

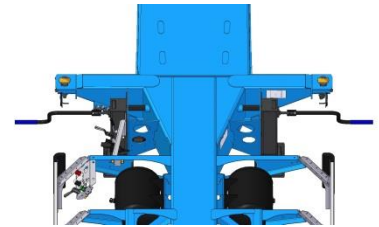

07-3

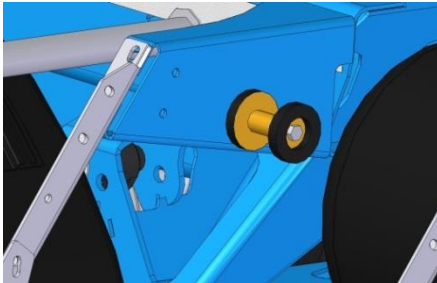

17-8-2

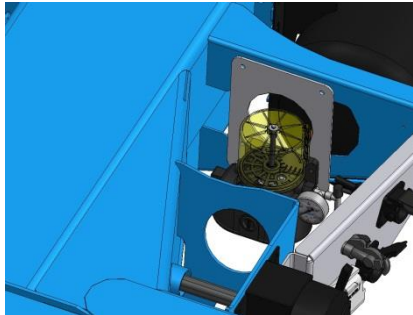

07-5



17-7

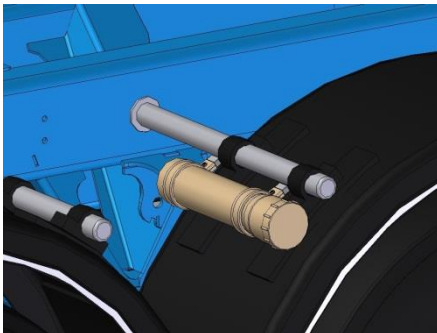

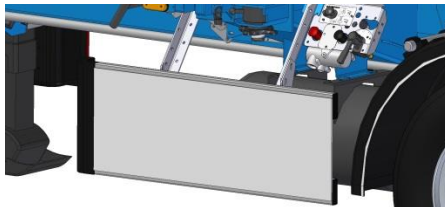

21-3



17-19



 <b>Basis opties</b>		 <b>Basis Optionen</b>		 <b>Basic options</b>	
11-4-15	Valx trommelremmen Standard 2-layer coating in RAL 3002, RAL 5002,	11-4-15	Valx Trommelbremsen RAL 5010, RAL 5015, RAL 7016,	11-4-15	Valx drumbrakes RAL 7021, RAL 9005
09-1-2	Schooperen bovenzijde	09-1-2	Spritzverzinken Oberseite	09-1-2	Schooping topside
17-21	Brede spatlap onder de bumper	17-21	Breiter Schmutzfänger	17-21	Mudflap under bumper
21-5	Wielkeggen (4x)	21-5	Radkeile (4x)	21-5	Wheelwedges (4x)
 <b>Comfort opties</b>		 <b>Komfort Optionen</b>		 <b>Comfort options</b>	
11-NS-15	SAF schijfremmen	11-NS-15	SAF Scheiben	11-NS-15	SAF discbrakes
17-8-2	Centrale smering	17-8-2	Zentralschmieranlage	17-8-2	Auto greasing system
13-9	Voeding EBS ook via remlichten	13-9	Strom EBS auch über Bremse	13-9	Power for EBS by brakelights too
11-3	2e rijhoogte	11-3	2. Fahrhöhe	11-3	2nd drive-height
19-55-65	Vorstuk met 385/55 en achterstuk met 385/65	19-55-65	Vorderteil auf 385/55, Hinterteil mit 385/65	19-55-65	Front part 385/55, Rear part 385/65
19-65	Bandenmaat 385/65R22,5.	19-65	Reifengröße 385/65 R22,5	19-65	Tyresize 385/65 R22,5
	Hankook / Continental HTR2		Goodyear LHT II / GT /		Bridgestone / Michelin
19-7-5	Alcoa DB	19-7-5	Alcoa DB	19-7-5	Alcoa DB
19-8-5	Speedline 10 aluminium velgen Reservewiel (staal) met band	19-8-5	Speedline 10 aluminium Felgen Reserverad Stahlfelge	19-8-5	Speedline 10 alloy rims Sparewheel (steel) with tyre
09-1-1	Schooperen volledig	09-1-1	Spritzverzinken völlig	09-1-1	Schooping full
15-12	6x ronde 3-kamer lampen, alles LED	15-12	6x Runde 3-Kammerleuchten LED	15-12	6 Round lights, LED
15-NS-14	4 x ronde lampen	15-NS-14	4x Runde 3-Kammerleuchten	15-NS-14	4 Round lights
05-17	Klapkokers ivm geen tunnel	05-17	Klappstützen wegen ohne Tunnel	05-17	Filling pieces due to no tunnel
07-1	Kunststof gereedschapskist links.	07-1	Kunststoff Werkzeugkasten links	07-1	Plastic toolbox
07-2	Steuropoten in de kopbalk	07-2	Stützen im Frontbalken	07-2	Legs in frontbeam
07-3	Kingpenslohouder 2x	07-3	Halter für Königszapfenverriegelung 2x	07-3	Holder for kingpinlock 2x
07-5	Gevaarlijke stoffen bord	07-5	Gefahrgutschild	07-5	ADR sign at the rear, orange
07-28	A-bord 2x	07-28	A-Schild 2x	07-28	A-sign (waste) 2x
07-NS-39	Jost Modul met 2 slingers achterstuk	07-NS-39	Jost Modul mit 2 Kurbel am Hinterteil	07-NS-39	Jost Modul with 2 cranks on rearpart
07-NS-9	Reclameplaat (alleen op achterstuk)	07-NS-9	Werbungstafel Stahl (nur am Heckteil)	07-NS-9	Steel plate (only at rear part)
17-19	Reservewiel drager	17-19	Reserveradträger	17-19	Sparewheelcarrier
17-22	Antispray achterstuk (385/65)	17-22	Anti-spray Hinterteil (385/65)	17-22	Anti-spray rearpart (385/65)
17-7	Documenten koker uit plastic	17-7	Dokubox Kunststoff	17-7	Document tube
21-3	Zijbeplating witte trespa	21-3	Seitl. Unterfahrschutz Trespa, weiß	21-3	Trespa sidefenders, white
21-8	Kingpinslot	21-8	Königszapfenverriegelung	21-8	Kingpinlock
03-4-A	ADR-fabrikantverklaring	03-4-A	ADR Herstellerbestätigung	03-4-A	ADR Manufacturer certificate
13-8	België: testnippels voor remdrukken	13-8	Nür für BE	13-8	BE only
25-NS-2	LZV uitgevoerd en gekeurd	25-NS-2	nur für NL	25-NS-2	NL only
17-2	ADR/VLG uitvoering incl certificaten	17-2	nur für NL	17-2	NL only
11-18	Multifunctioneel display	11-18	Multifunktionales Display	11-18	Multifunctional Display
11-19	Schakelaar om as 1 te laten zakken	11-19	Switch for axle 1 (to lower)	11-19	Schalter für senken 1. Achse

